

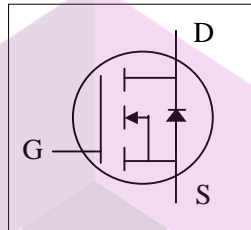

- ▼ Low On-Resistance
- ▼ Fast Switching
- ▼ Simple Drive Requirement
- ▼ RoHS Compliant



| | |
|--------------|----------------|
| BV_{DSS} | 30V |
| $R_{DS(ON)}$ | 13.5m Ω |
| I_D | 55A |

Description

The Advanced Power MOSFETs from APEC provide the designer with the best combination of fast switching, ruggedized device design, low on-resistance and cost-effectiveness.

The TO-252 package is universally preferred for all commercial-industrial surface mount applications and suited for low voltage applications such as DC/DC converters. The through-hole version (AP60N03GJ) is available for low-profile applications.

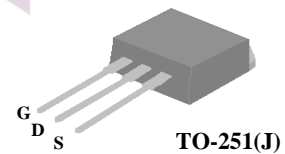
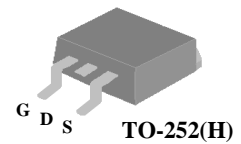

Absolute Maximum Ratings

| Symbol | Parameter | Rating | Units |
|-------------------------|--|------------|---------------|
| V_{DS} | Drain-Source Voltage | 30 | V |
| V_{GS} | Gate-Source Voltage | ± 20 | V |
| $I_D @ T_C=25^\circ C$ | Continuous Drain Current, $V_{GS} @ 10V$ | 55 | A |
| $I_D @ T_C=100^\circ C$ | Continuous Drain Current, $V_{GS} @ 10V$ | 35 | A |
| I_{DM} | Pulsed Drain Current ¹ | 215 | A |
| $P_D @ T_C=25^\circ C$ | Total Power Dissipation | 62.5 | W |
| | Linear Derating Factor | 0.5 | W/ $^\circ C$ |
| T_{STG} | Storage Temperature Range | -55 to 150 | $^\circ C$ |
| T_J | Operating Junction Temperature Range | -55 to 150 | $^\circ C$ |

Thermal Data

| Symbol | Parameter | Value | Units |
|--------|-------------------------------------|----------|--------------|
| Rthj-c | Thermal Resistance Junction-case | Max. 2.0 | $^\circ C/W$ |
| Rthj-a | Thermal Resistance Junction-ambient | Max. 110 | $^\circ C/W$ |

تهیه و توزیع قطعات الکترونیک

Electrical Characteristics @ $T_j=25^{\circ}\text{C}$ (unless otherwise specified)

| Symbol | Parameter | Test Conditions | Min. | Typ. | Max. | Units |
|------------------------------|--|--|------|-------|-----------|-----------------------------|
| BV_{DSS} | Drain-Source Breakdown Voltage | $V_{GS}=0V, I_D=250\mu A$ | 30 | - | - | V |
| $\Delta BV_{DSS}/\Delta T_j$ | Breakdown Voltage Temperature Coefficient | Reference to 25°C , $I_D=1\text{mA}$ | - | 0.037 | - | $\text{V}/^{\circ}\text{C}$ |
| $R_{DS(ON)}$ | Static Drain-Source On-Resistance | $V_{GS}=10V, I_D=28A$ | - | 11.5 | 13.5 | $\text{m}\Omega$ |
| | | $V_{GS}=4.5V, I_D=22A$ | - | 18 | 20 | $\text{m}\Omega$ |
| $V_{GS(th)}$ | Gate Threshold Voltage | $V_{DS}=V_{GS}, I_D=250\mu A$ | 1 | - | 3 | V |
| g_{fs} | Forward Transconductance | $V_{DS}=10V, I_D=28A$ | - | 30 | - | S |
| I_{DSS} | Drain-Source Leakage Current ($T_j=25^{\circ}\text{C}$) | $V_{DS}=30V, V_{GS}=0V$ | - | - | 1 | μA |
| | Drain-Source Leakage Current ($T_j=150^{\circ}\text{C}$) | $V_{DS}=24V, V_{GS}=0V$ | - | - | 25 | μA |
| I_{GSS} | Gate-Source Leakage | $V_{GS}=\pm 20V$ | - | - | ± 100 | nA |
| Q_g | Total Gate Charge ² | $I_D=28A$ | - | 22.4 | - | nC |
| Q_{gs} | Gate-Source Charge | $V_{DS}=24V$ | - | 2.7 | - | nC |
| Q_{gd} | Gate-Drain ("Miller") Charge | $V_{GS}=5V$ | - | 14 | - | nC |
| $t_{d(on)}$ | Turn-on Delay Time ² | $V_{DS}=15V$ | - | 7.4 | - | ns |
| t_r | Rise Time | $I_D=28A$ | - | 81 | - | ns |
| $t_{d(off)}$ | Turn-off Delay Time | $R_G=3.3\Omega, V_{GS}=10V$ | - | 24 | - | ns |
| t_f | Fall Time | $R_D=0.53\Omega$ | - | 18 | - | ns |
| C_{iss} | Input Capacitance | $V_{GS}=0V$ | - | 950 | - | pF |
| C_{oss} | Output Capacitance | $V_{DS}=25V$ | - | 440 | - | pF |
| C_{rss} | Reverse Transfer Capacitance | $f=1.0\text{MHz}$ | - | 145 | - | pF |

Source-Drain Diode

| Symbol | Parameter | Test Conditions | Min. | Typ. | Max. | Units |
|----------|---|--|------|------|------|-------|
| I_S | Continuous Source Current (Body Diode) | $V_D=V_G=0V, V_S=1.3V$ | - | - | 55 | A |
| I_{SM} | Pulsed Source Current (Body Diode) ¹ | | - | - | 215 | A |
| V_{SD} | Forward On Voltage ² | $T_j=25^{\circ}\text{C}, I_S=55A, V_{GS}=0V$ | - | - | 1.3 | V |

Notes:

1. Pulse width limited by safe operating area.
2. Pulse width $\leq 300\mu s$, duty cycle $\leq 2\%$.

تهیه و توزیع قطعات الکترونیک

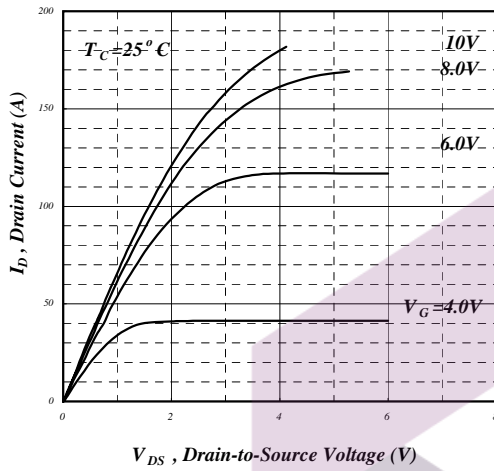

Fig 1. Typical Output Characteristics

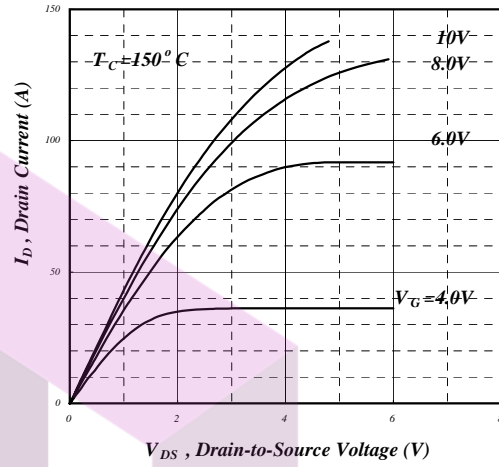

Fig 2. Typical Output Characteristics

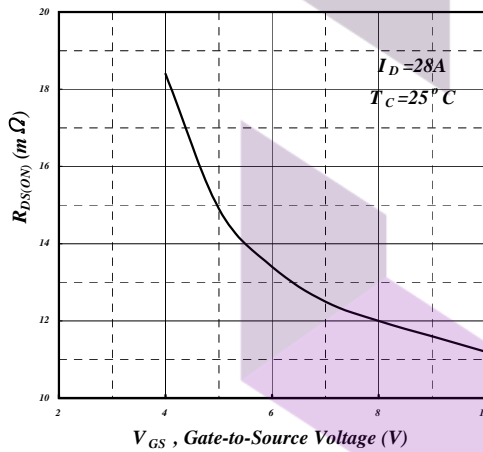

Fig 3. On-Resistance v.s. Gate Voltage

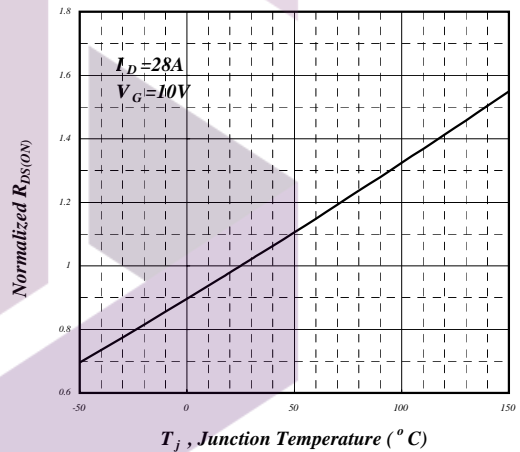

Fig 4. Normalized On-Resistance

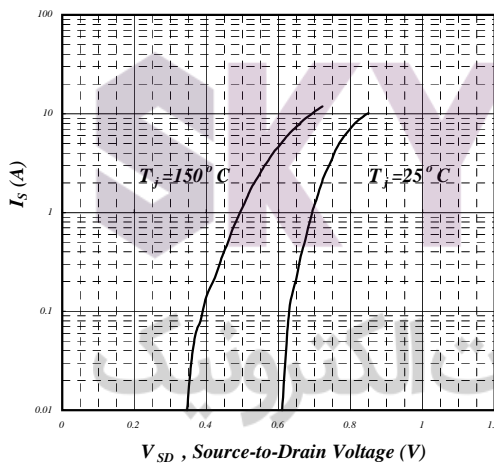

Fig 5. Forward Characteristic of Reverse Diode

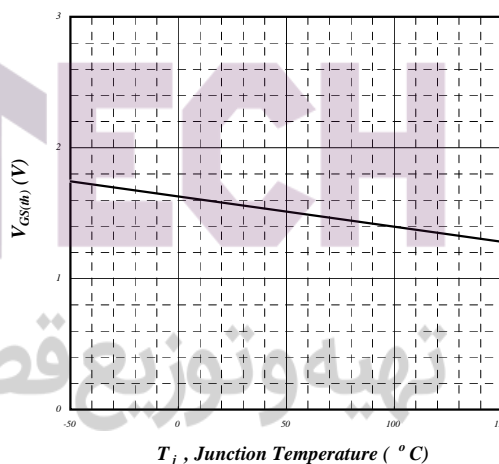

Fig 6. Gate Threshold Voltage v.s. Junction Temperature

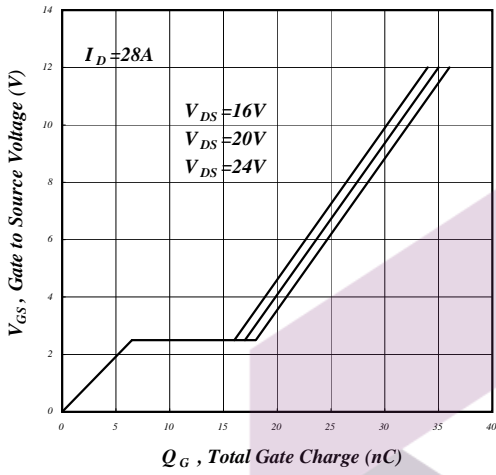

Fig 7. Gate Charge Characteristics

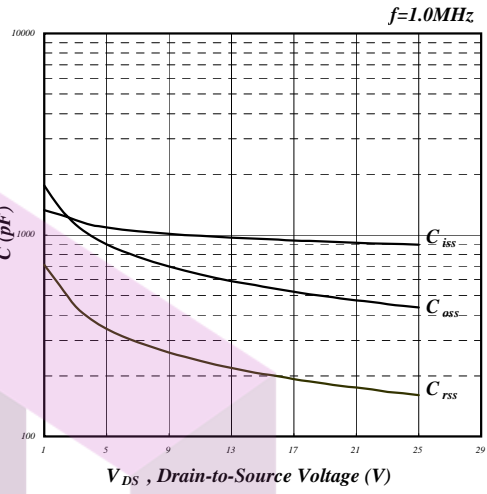

Fig 8. Typical Capacitance Characteristics

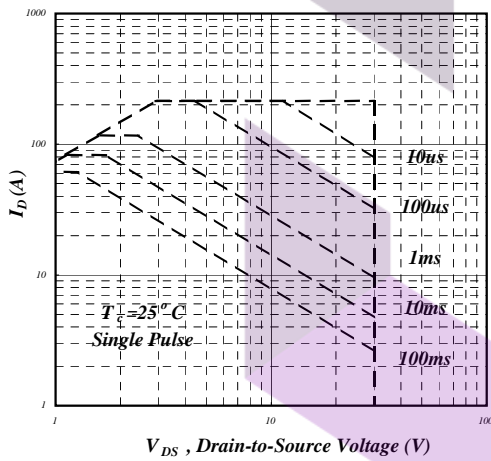

Fig 9. Maximum Safe Operating Area

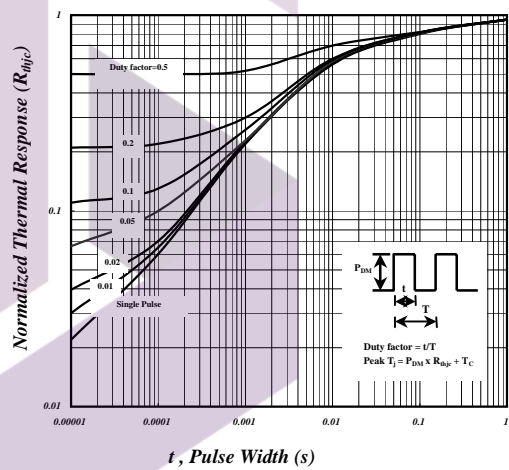

Fig 10. Effective Transient Thermal Impedance

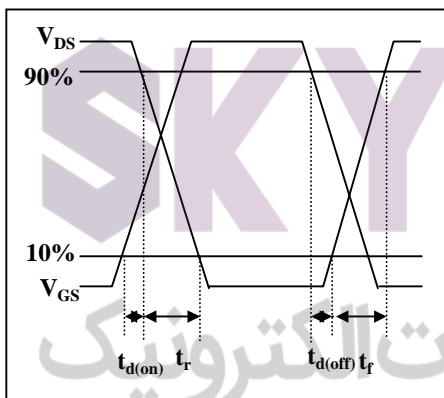

Fig 11. Switching Time Waveform

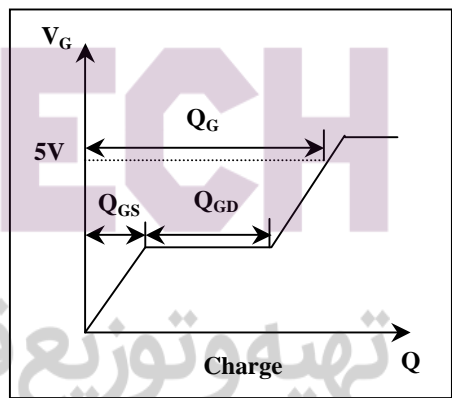

Fig 12. Gate Charge Waveform